



10114

Test Booklet Series | A

ROLL No.

--	--	--	--	--

TEST BOOKLET No.

29585

TEST FOR FIRST DEGREE PROGRAMMES IN ENGINEERING AND TECHNOLOGY**MATHEMATICS, PHYSICS AND CHEMISTRY**

Time: 3 Hours

Maximum Marks: 750

INSTRUCTIONS TO CANDIDATES

1. You are provided with a Test Booklet and an Optical Mark Reader (OMR) Answer Sheet with a carbonless copy to mark your responses. Do not soil the Answer Sheet. Read carefully all the instructions given on the Answer Sheet.
2. Write your Roll Number in the space provided on the top of this page.
3. Also write your Roll Number in the columns provided for the same on the **Answer Sheet**. Darken the appropriate bubbles with a **Ball Point Pen**. Put your signature in the column provided on the Answer Sheet in the presence of the Invigilator.
4. Darken the appropriate bubble corresponding to the Test Booklet Series, as given on the top of this page, in the Answer Sheet. **If the corresponding bubble is not darkened, such answer sheets will not be valued and will be summarily rejected.**
5. The paper consists of 250 objective type questions. Of this, Question No. 1 to 125 will be Mathematics, 126 to 200 will be Physics and 201 to 250 will be Chemistry. All questions carry equal marks.
6. Each question has four alternative responses marked **A, B, C** and **D** and you have to **darken** the bubble fully by **using a Ball Point Pen** corresponding to the correct response as indicated in the example shown on the Answer Sheet.
7. Each correct answer carries **3** marks and each wrong answer carries **1** minus mark.
8. Space for rough work is provided at the end of this Test Booklet.
9. You should return the Answer Sheet to the Invigilator before you leave the examination hall. However, you can retain the Test Booklet and the carbonless copy of the OMR sheet.
10. Every precaution has been taken to avoid errors in the Test Booklet. In the event of any such unforeseen happenings, the same may be brought to the notice of the Observer/Chief Superintendent in writing. Suitable remedial measures will be taken at the time of evaluation, if necessary.

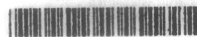

58282

[Faint, illegible text covering the majority of the page, likely bleed-through from the reverse side.]



MATHEMATICS

1. $\left(\sin\frac{\pi}{6} + i\cos\frac{\pi}{6}\right)^6$ is equal to

(A) -1
(C) i

(B) $-i$
(D) 1

2. The polar form of i^{27} is

(A) $(1, -1)$

(B) $\left(1, -\frac{\pi}{2}\right)$

(C) $\left(-1, \frac{\pi}{2}\right)$

(D) $\left(\sqrt{2}, -\frac{\pi}{4}\right)$

3. If ω is an n^{th} root of unity and n is even, then

(A) $1 + \omega^2 + \omega^4 + \dots + \omega^{n-2} = \omega + \omega^3 + \omega^5 + \dots + \omega^{n-1}$

(B) $\omega^n = 0$

(C) $\omega^{n/2} = 0$

(D) $\omega^{n/2} = -1$

4. The equation $\begin{vmatrix} 2x & 0 & 0 \\ x+2 & x+1 & 0 \\ x+3 & x+4 & x^2+1 \end{vmatrix} = 0$ has solutions

(A) $x = -1, -2, -3$

(B) $x = 0, -1, \pm i$

(C) $x = -2, -3, -4$

(D) $x = 0, 0, 0$

5. If $z = \frac{1+2i}{2-i} - \frac{2-i}{1+2i}$, then $z^2 + z\bar{z} =$
- (A) z (B) -1
(C) 0 (D) -8
6. The modulus of $\left[e^{\left(2-i\frac{3\pi}{2}\right)} \right]^5$ is
- (A) e^{-1} (B) e^{-7}
(C) e^{-14} (D) e^{10}
7. If θ is the angle between the vectors \vec{a} and \vec{b} , $|\vec{a} \times \vec{b}| = \sqrt{10}$ and $\vec{a} \cdot \vec{b} = \sqrt{30}$, then $\cos \theta =$
- (A) $\frac{1}{\sqrt{3}}$ (B) 1
(C) $\frac{1}{2}$ (D) $\frac{\sqrt{3}}{2}$
8. $y = \frac{\log x}{x^3}$ is an increasing function of x , only if
- (A) $x < e$ (B) $x < e^{\frac{1}{3}}$
(C) $0 < x < e^{\frac{1}{3}}$ (D) $0 < x < e^3$
9. If α and β are the roots of the equation $x^2 - 2x + 4 = 0$, then $\alpha^6 - \beta^6 =$
- (A) 64 (B) 128
(C) -128 (D) 0



10. The product of the four roots of $z^4 - i = 0$ is
- (A) 1 (B) -1
(C) $-i$ (D) i
11. Using differentials, an approximate value of $627^{\frac{1}{4}}$ is
- (A) 5.002 (B) 5.003
(C) 5.005 (D) 5.004
12. $\lim_{x \rightarrow 0} (\cos x)^{\cot x} =$
- (A) 1 (B) 0
(C) $\frac{1}{e}$ (D) $\frac{1}{e^2}$
13. The curve $f(x) = x^3 - 6x^2 + 9x - 8$ is concave upward when
- (A) $x \in (2, \infty)$ (B) $x \in (-\infty, 2)$
(C) $x \in (0, \infty)$ (D) $x \in (-\infty, 0)$
14. If a, b, c are all different and nonzero and if $\begin{vmatrix} 1+a & 1 & 1 \\ 1 & 1+b & 1 \\ 1 & 1 & 1+c \end{vmatrix} = 0$,
- then the value of $\frac{1}{a} + \frac{1}{b} + \frac{1}{c}$ is
- (A) 0 (B) -1
(C) $\frac{1}{abc}$ (D) 1



15. If $f(x) = \frac{1}{1+x}$, then $f^{(n)}(0) =$
- (A) $(-1)^n n!$ (B) $\frac{(-1)^n}{n!}$
(C) $\frac{1}{n!}$ (D) $\frac{1}{n}$
16. If $u(x, y) = x^y + y^x$, then $u_x(e, 1)$ is
- (A) e (B) 1
(C) $e+1$ (D) $2e$
17. $\lim_{x \rightarrow 5} \frac{x^k - 5^k}{x - 5} = 500$, then the positive value of k is
- (A) 3 (B) 4
(C) 5 (D) 6
18. If $A = \begin{bmatrix} 3 & -1 \\ -4 & 5 \end{bmatrix}$, then the value of $|AA^T|$ is
- (A) 3^2 (B) 4^2
(C) 5^2 (D) 11^2
19. If $(G, *)$ is a group, $a, b \in G$, then $(b^{-1} * a * b)^3 =$
- (A) $(b^{-1})^3 * a^3 * b^3$ (B) $b^{-1} * a^3 * b$
(C) $b^{-1} * a * b^3$ (D) $(b^{-1})^3 * a * b^3$



20. If $3 - i$ is a solution of $x^2 - 6x + k = 0$, then $k =$
- (A) 5 (B) $\sqrt{5}$
(C) $\sqrt{10}$ (D) 10
21. For the curve $x = e^t \cos t$, $y = e^t \sin t$, the tangent line at t is parallel to the x -axis when t is equal to
- (A) $\frac{-\pi}{4}$ (B) $\frac{\pi}{4}$
(C) $\frac{\pi}{2}$ (D) 0
22. If $u = \log(e^x + e^y)$, then $\frac{\partial u}{\partial x} + \frac{\partial u}{\partial y} =$
- (A) $e^x + e^y$ (B) $\frac{1}{e^x + e^y}$
(C) 2 (D) 1
23. The number of points of inflection of the curve $y = x^{\frac{1}{3}}$ is
- (A) 0 (B) 1
(C) 2 (D) 3
24. If $(x + iy)^{\frac{1}{3}} = a + ib$, then $\frac{x}{a} + \frac{y}{b}$ is equal to
- (A) $4(a^2 - b^2)$ (B) $4ab$
(C) $4(a^2 + b^2)$ (D) $5ab$



25. If $\sin x$ is an integrating factor of the differential equation $\frac{dy}{dx} + Py = Q$, then P can be
- (A) $\log \sin x$ (B) $\cot x$
(C) $\sin x$ (D) $\log \cos x$
26. The interval in which the function $(x-3)^2$ is strictly increasing, is
- (A) $(-\infty, 3)$ (B) $(-3, \infty)$
(C) $(3, \infty)$ (D) $(-\infty, \infty)$
27. Which of the following is a root of the equation $\begin{vmatrix} x & a & a \\ a & x & a \\ a & a & x \end{vmatrix} = 0$?
- (A) $-a$ (B) $2a$
(C) $-2a$ (D) $3a$
28. A train 280m long, running with a speed of 63 km/hour will pass a pillar in
- (A) 15 sec (B) 16 sec
(C) 18 sec (D) 20 sec
29. The ratio of the areas of the incircle and the circumcircle of a square is
- (A) $\frac{1}{2}$ (B) $\frac{1}{3}$
(C) $\frac{1}{4}$ (D) 1



10114

Series A

7

30. If every element in a group is self-inverse, then the group is
- (A) cyclic (B) non-abelian
(C) cyclic and abelian (D) abelian
31. The angle between the asymptotes of the hyperbola $\frac{x^2}{a^2} - \frac{y^2}{b^2} = 1$, with the eccentricity e , is
- (A) $\tan^{-1}\left(\frac{b}{a}\right)$ (B) $2 \tan^{-1}\left(\frac{a}{b}\right)$
(C) $2 \sec^{-1}(e)$ (D) $2 \sec^{-1}\left(\frac{1}{e}\right)$
32. The integrating factor of $\frac{dy}{dx} + y \cot x = 4x \operatorname{cosec} x$ is
- (A) $\operatorname{cosec} x$ (B) $\cot x$
(C) $\cos x$ (D) $\sin x$
33. The conjugate of $i^{13} + i^{14} + i^{15} + i^{16}$ is
- (A) 1 (B) -1
(C) 0 (D) -i
34. The line $lx - 2y + 3 = 0$ is a tangent to the parabola $4y^2 = x$ if $l =$
- (A) 12 (B) $\frac{1}{12}$
(C) $\pm \frac{1}{3}$ (D) 3
35. If $x + y = 22$ and $x^2 + y^2 = 404$, then $xy =$
- (A) 40 (B) 44
(C) 80 (D) 88



36. If the remainder and the quotient when 4150 divided by x are 25 and 55, then $x =$
- (A) 65 (B) 70
(C) 75 (D) 80
37. The largest number from $\sqrt{2}$, $\sqrt[3]{3}$ and $\sqrt[4]{4}$ is
- (A) $\sqrt{2}$ (B) $\sqrt[4]{4}$
(C) $\sqrt[3]{3}$ (D) $\sqrt{2} = \sqrt[3]{3} = \sqrt[4]{4}$
38. In the group $G = \{4, 8, 12, 16\}$ under multiplication modulo 20, the identity element is
- (A) 4 (B) 8
(C) 12 (D) 16
39. The set $G = \left\{ \begin{bmatrix} a & 0 \\ 0 & b \end{bmatrix} \mid a, b \in R \right\}$ under matrix multiplication forms
- (A) an abelian group (B) non-abelian group
(C) monoid but not a group (D) None of the above
40. If $(1+2+3+\dots+n)^x = (1^3+2^3+\dots+n^3)^2$, then $x =$
- (A) 1 (B) 3
(C) 4 (D) 2



41. The function f whose graph passes through $(0, 7/3)$ and whose derivative is $x\sqrt{1-x^2}$ is given by

(A) $f(x) = \left(-\frac{1}{3}\right) \left[(1-x^2)^{\frac{3}{2}} - 8 \right]$

(B) $f(x) = \left(\frac{1}{3}\right) \left[(1-x^2)^{\frac{3}{2}} + 8 \right]$

(C) $f(x) = \left(-\frac{1}{3}\right) \left[(\sin^{-1} x) + 7 \right]$

(D) $f(x) = -\frac{1}{3} \left[(1-x^2)^3 + 8 \right]$

42. If a, b, c are distinct nonzero integers such that a, ab, abc are in A.P., then

(A) $c = 1$

(B) $c = 2$

(C) $c = 3$

(D) $c = 4$

43. If A is a square matrix such that $A^3 = 0$, then $(I+A)^{-1}$ is

(A) $I-A$

(B) $I+A^{-1}$

(C) $I+A+A^2$

(D) $I-A+A^2$

44. Volume of the parallelepiped whose conterminal edges are $2\vec{i} - 3\vec{j} + 4\vec{k}$, $\vec{i} + 2\vec{j} - 2\vec{k}$, $3\vec{i} - \vec{j} + \vec{k}$ is

(A) 5 units

(B) 6 units

(C) 7 units

(D) 8 units



45. The length of the latus rectum of the ellipse $5x^2 + 9y^2 = 45$, is
- (A) $\frac{5}{3}$ (B) $\frac{10}{3}$
 (C) $\frac{2\sqrt{5}}{5}$ (D) $\frac{\sqrt{5}}{3}$
46. If $f(x) = \begin{vmatrix} \sin x + \sin 2x + \sin 3x & \sin 2x & \sin 3x \\ 3 + 4\sin x & 3 & 4\sin x \\ 1 + \sin x & \sin x & 1 \end{vmatrix}$, then the value of $\int_0^{\pi/2} f(x) dx$ is
- (A) 3 (B) $\frac{2}{3}$
 (C) $\frac{1}{3}$ (D) 0
47. If $f'(x)$ is continuous at $x=0$ and $f''(0) = a$, then the value of $\lim_{x \rightarrow 0} \left[\frac{2f(x) - 3f(2x) + f(4x)}{x^2} \right]$ is
- (A) a (B) $3a$
 (C) $4a$ (D) $6a$
48. If $y^2 = P(x)$ is a polynomial of degree 3, then $2 \frac{d}{dx} \left(y^3 \frac{d^2 y}{dx^2} \right)$ is equal to
- (A) $P(x) + P'(x)$ (B) $P(x) P'(x)$
 (C) $P(x) P'''(x)$ (D) a constant
49. The least positive integer to which $79 \times 101 \times 125 \equiv \text{mod } 11$ is
- (A) 5 (B) 6
 (C) 4 (D) 8



50. Which one of the following subsets of S_3 is a subgroup of S_3 ?
- (A) $\left\{ \begin{pmatrix} 1 & 2 & 3 \\ 1 & 2 & 3 \end{pmatrix}, \begin{pmatrix} 1 & 2 & 3 \\ 2 & 3 & 1 \end{pmatrix} \right\}$ (B) $\left\{ \begin{pmatrix} 1 & 2 & 3 \\ 1 & 3 & 2 \end{pmatrix}, \begin{pmatrix} 1 & 2 & 3 \\ 2 & 1 & 3 \end{pmatrix} \right\}$
- (C) $\left\{ \begin{pmatrix} 1 & 2 & 3 \\ 1 & 2 & 3 \end{pmatrix}, \begin{pmatrix} 1 & 2 & 3 \\ 3 & 2 & 1 \end{pmatrix} \right\}$ (D) $\left\{ \begin{pmatrix} 1 & 2 & 3 \\ 1 & 2 & 3 \end{pmatrix}, \begin{pmatrix} 1 & 2 & 3 \\ 3 & 1 & 2 \end{pmatrix} \right\}$
51. Lines $ax + by + c = 0$ where $3a + 2b + 4c = 0$, $a, b, c \in R$ are concurrent at the point
- (A) (3, 2) (B) (2, 4)
- (C) (3, 4) (D) $\left(\frac{3}{4}, \frac{1}{2}\right)$
52. The number of points (p, q) such that $p, q \in \{1, 2, 3, 4\}$ and the equation $px^2 + qx + 1 = 0$ has real roots is
- (A) 7 (B) 8
- (C) 9 (D) 10
53. The complex numbers $\sin x + i\cos 2x$ and $\cos x - i\sin 2x$ are conjugates to each other for
- (A) $x = n\pi$ (B) $x = n\pi/2$
- (C) $x = 0$ (D) no value of x
54. If $A = \begin{bmatrix} 2 & 0 & 0 \\ 0 & 2 & 0 \\ 0 & 0 & 2 \end{bmatrix}$, then A^5 is
- (A) A (B) $4A$
- (C) $16A$ (D) $32A$

55. If $A = \begin{bmatrix} 1 & \sin \theta & 1 \\ -\sin \theta & 1 & \sin \theta \\ -1 & -\sin \theta & 1 \end{bmatrix}$, then $|A|$ lies in

(A) [2, 3]

(B) [3, 4]

(C) [2, 4]

(D) [3, 5]

56. If T_p, T_q, T_r are the $p^{\text{th}}, q^{\text{th}}, r^{\text{th}}$ terms of an A.P., then $\begin{vmatrix} T_p & T_q & T_r \\ p & q & r \\ 1 & 1 & 1 \end{vmatrix} =$

(A) 1

(B) -1

(C) 0

(D) 2

57. Sum of $1+4+7+10+\dots+n$ terms is

(A) $\frac{n(3n-7)}{2}$

(B) $\frac{n(3n-1)}{2}$

(C) $\frac{n(3n+1)}{3}$

(D) $\frac{(3n-1)(3n+1)}{3}$

58. If $f(2) = 4$ and $f'(2) = 1$, then $\lim_{x \rightarrow 2} \left[\frac{xf(2) - 2f(x)}{x-2} \right] =$

(A) 1

(B) -2

(C) 2

(D) 3



10114

59. If $4\sin^{-1}x + \cos^{-1}x = \pi$, then x equals
- (A) $\frac{1}{2}$ (B) $\frac{\sqrt{3}}{2}$
(C) $-\frac{1}{2}$ (D) $-\frac{1}{4}$
60. The curve represented by $x = a(\cosh \theta + \sinh \theta)$, $y = b(\cosh \theta - \sinh \theta)$ is
- (A) a hyperbola (B) an ellipse
(C) a parabola (D) a circle
61. Solution of $\frac{2x-3}{3x-5} \geq 3$ is
- (A) $\left[1, \frac{12}{7}\right)$ (B) $\left(\frac{5}{3}, \frac{12}{7}\right]$
(C) $\left(-\infty, \frac{5}{3}\right)$ (D) $\left[\frac{12}{7}, \infty\right)$
62. The number of integral solutions of $\frac{x+2}{x^2+1} > \frac{1}{2}$ is
- (A) 4 (B) 5
(C) 3 (D) 2
63. $\left(\frac{1+i}{1-i}\right)^2 + \left(\frac{1-i}{1+i}\right)^2$ is
- (A) $2i$ (B) $-2i$
(C) -2 (D) 2

64. If z is any complex number such that $|z+4| \leq 3$, then the least value and the greatest value of $|z+1|$ are
- (A) 1, 6
(B) 0, 6
(C) 2, 8
(D) 2, 6
65. If $z = i \log(2 - \sqrt{3})$, then $\cos z$ is equal to
- (A) i
(B) $2i$
(C) 1
(D) 2
66. Locus of the point z satisfying the equation $|iz-1| + |z-i| = 2$ is
- (A) a straight line
(B) a circle
(C) an ellipse
(D) a pair of straight line
67. The equation not representing a circle is given by
- (A) $\operatorname{Re}\left(\frac{1+z}{1-z}\right) = 0$
(B) $z\bar{z} + iz - i\bar{z} + 1 = 0$
(C) $\arg\left(\frac{z-1}{z+1}\right) = \frac{\pi}{2}$
(D) $\left|\frac{z-1}{z+1}\right| = 1$
68. If the sum of a number and its square is 240, what is the number?
- (A) 12
(B) 13
(C) 14
(D) 15
69. The common roots of the equation $z^3 + 2z^2 + 2z + 1 = 0$ and $z^{1984} + z^2 + 1 = 0$ are
- (A) $-1, \omega$
(B) $-1, \omega^2$
(C) ω, ω^2
(D) $1, -1$



10114

Series A

15

70. The maximum value of $|z|$ when z satisfies the condition $\left|z + \frac{2}{z}\right| = 2$ is

- (A) $\sqrt{3} - 1$ (B) $\sqrt{3} + 1$
(C) $\sqrt{3}$ (D) $\sqrt{2} + \sqrt{3}$

71. The product of all values of $(\cos \alpha + i \sin \alpha)^{\frac{3}{5}}$ is

- (A) 1 (B) $\cos \alpha + i \sin \alpha$
(C) $\cos 3\alpha + i \sin 3\alpha$ (D) $\cos 5\alpha + i \sin 5\alpha$

72. If $\log_{10} 2$, $\log_{10} (2^x - 1)$ and $\log_{10} (2^x + 3)$ be three consecutive terms of an A.P., then

- (A) $x = 0$ (B) $x = 1$
(C) $x = \log_2 5$ (D) $2^x = -1$

73. The sum of positive terms of the series $10 + \frac{67}{7} + \frac{64}{7} + \dots$ is

- (A) $\frac{352}{7}$ (B) $\frac{437}{7}$
(C) $\frac{752}{7}$ (D) $\frac{852}{7}$

A



74. If the sum of first n terms of a series is $5n^2 + 2n$, then its second term is
- (A) 16 (B) 17
(C) $\frac{27}{14}$ (D) $\frac{56}{15}$
75. Sum of the series $1 + 2.2 + 3.2^2 + 4.2^3 + \dots + 100.2^{99}$ is
- (A) $100.2^{100} + 1$ (B) $99.2^{100} - 1$
(C) $99.2^{99} + 1$ (D) $100.2^{100} - 1$
76. If $\frac{1}{4-3i}$ is a root of $ax^2 + bx + 1 = 0$, where a, b are real, then
- (A) $a = 25, b = -8$ (B) $a = 1, b = -\frac{8}{25}$
(C) $a = 5, b = 4$ (D) $a = 5, b = 8$
77. If $ax^2 + bx + 10 = 0$ does not have two distinct real roots, then the least value of $5a + b$ is
- (A) -3 (B) -2
(C) 3 (D) 0
78. The number of real solutions of the equation $e^x = x$ is
- (A) 1 (B) 2
(C) 0 (D) infinite
79. If α and β are the roots of $x^2 - 2x + 4 = 0$, then the value of $\alpha^6 + \beta^6$ is
- (A) 32 (B) 64
(C) 128 (D) 256



10114

Series A

17

80. If a, b, c are three natural numbers in A.P. and $a+b+c=21$, then the possible number of values of the ordered triplet (a, b, c) is
- (A) 15 (B) 14
(C) 13 (D) 11
81. Number of divisors of the form $4n+2$ ($n \geq 0$) of the integer 240 is
- (A) 4 (B) 8
(C) 10 (D) 3
82. If $(1+x+x^2+x^3)^5 = \sum_{k=0}^{15} a_k x^k$, then $\sum_{k=0}^7 a_{2k}$ is equal to
- (A) 128 (B) 256
(C) 512 (D) 1024
83. The digit at the unit place in the number $19^{2005} + 11^{2005} - 9^{2005}$ is
- (A) 0 (B) 1
(C) 2 (D) 8
84. For $|x| < 1$, the constant term in the expansion of $\frac{1}{(x-1)^2(x-2)}$ is
- (A) 2 (B) 1
(C) 0 (D) $-\frac{1}{2}$
85. The matrix $\begin{bmatrix} \cos \alpha & \sin \alpha \\ -\sin \alpha & \cos \alpha \end{bmatrix}$ is
- (A) symmetric (B) unique
(C) orthogonal (D) scalar

86. If $D = \begin{vmatrix} 1 & a & b \\ 1 & b & c \\ 1 & c & a \end{vmatrix}$, then $\begin{vmatrix} a & b & c \\ b & c & a \\ 1 & 1 & 1 \end{vmatrix}$ equals

- (A) 0
(B) D
(C) $-D$
(D) $3D$

87. If a, b, c are in A.P., then the value of $\begin{vmatrix} x+1 & x+2 & x+a \\ x+2 & x+3 & x+b \\ x+3 & x+4 & x+c \end{vmatrix}$ is

- (A) 3
(B) -3
(C) 0
(D) 1

88. If one of the roots of the equation $\begin{vmatrix} 7 & 6 & x \\ 2 & x & 2 \\ x & 3 & 7 \end{vmatrix} = 0$ is $x = -9$, then the

other two roots are

- (A) $\{2, 6\}$
(B) $\{3, 6\}$
(C) $\{2, 7\}$
(D) $\{3, 7\}$

89. If $f(x) = \begin{vmatrix} 1 & x & x+1 \\ 2x & x(x-1) & (x+1)x \\ 3x(x-1) & x(x-1)(x-2) & (x+1)x(x-1) \end{vmatrix}$, then $f(100)$ is

equal to

- (A) 0
(B) 1
(C) 100
(D) -100



10114

Series A

19

90. If x, y, z are in A.P. with common difference d and the rank of the matrix $\begin{vmatrix} 4 & 5 & x \\ 5 & 6 & y \\ 6 & k & z \end{vmatrix}$ is 2, then the values of d and k are
- (A) $\frac{\lambda}{4}$, arbitrary number (B) arbitrary number, 7
(C) $x, 5$ (D) $\frac{\lambda}{2}, 6$
91. Sum of the series $1 + \frac{3}{1!} + \frac{5}{2!} + \frac{7}{3!} + \dots$ is
- (A) e^{-1} (B) $2e$
(C) $3e$ (D) $5e - 7$
92. The coefficient of x^k in the expansion of $\frac{1 - 2x - x^2}{e^{-x}}$ is
- (A) $\frac{1 - k - k^2}{k!}$ (B) $\frac{k^2 + 1}{k!}$
(C) $\frac{1 - k}{k!}$ (D) $\frac{1}{k!}$
93. If $\frac{1}{e^{3x}}(e^x + e^{5x}) = a_0 + a_1x + a_2x^2 + \dots$, then $2a_1 + 2^3a_3 + 2^5a_5 + \dots$ is equal to
- (A) e (B) e^{-1}
(C) 1 (D) 0

94. The number of mappings from the set $A = \{1, 2, \dots, 100\}$ to set $B = \{1, 2\}$ is
- (A) $2^{100} - 2$ (B) 2^{100}
(C) $2^{99} - 2$ (D) 2^{99}
95. Two finite sets A and B have m and n elements respectively. If the total number of subsets of A is 112 more than the total number of subsets of B , then the value of m is
- (A) 7 (B) 9
(C) 10 (D) 12
96. The maximum value of $3 \cos \theta + 4 \sin \theta$ is
- (A) 3 (B) 4
(C) 5 (D) 7
97. $\sqrt{3} \operatorname{cosec} 20^\circ - \sec 20^\circ$ is equal to
- (A) 2 (B) $2 \sin 20^\circ \operatorname{cosec} 40^\circ$
(C) 4 (D) $4 \sin 20^\circ \operatorname{cosec} 40^\circ$
98. If $12 \cot^2 \theta - 31 \operatorname{cosec} \theta + 32 = 0$, then the value of $\sin \theta$ is
- (A) $\frac{3}{5}$ or 1 (B) $\frac{2}{3}$ or $-\frac{2}{3}$
(C) $\frac{4}{5}$ or $\frac{3}{4}$ (D) $\pm \frac{1}{2}$
99. If $\alpha + \beta - \gamma = \pi$, then $\sin^2 \alpha + \sin^2 \beta - \sin^2 \gamma$ is equal to
- (A) $2 \sin \alpha \sin \beta \cos \gamma$ (B) $2 \cos \alpha \cos \beta \cos \gamma$
(C) $2 \sin \alpha \sin \beta \sin \gamma$ (D) $2 \cos \alpha \sin \beta \cos \gamma$



10114

21

Series A

100. If $A+B=45^\circ$, then $(\cot A-1)(\cot B-1)$ is equal to
- (A) 1 (B) -2
(C) -1 (D) 2
101. If $\tan x = \frac{b}{a}$, then the value of $a \cos 2x + b \sin 2x$ is
- (A) 1 (B) ab
(C) b (D) a
102. If $\cos 2\alpha = \frac{3 \cos 2\beta - 1}{3 \cos 2\beta}$, then $\tan \alpha$ is equal to
- (A) $\sqrt{2} \tan \beta$ (B) $\tan \beta$
(C) $\sin 2\beta$ (D) $\sqrt{2} \cot 2\beta$
103. The equation $\sqrt{3} \sin x + \cos x = 4$ has
- (A) only one solution (B) two solutions
(C) infinitely many solutions (D) no solution
104. The general value of θ in the equations $\cos \theta = \frac{1}{\sqrt{2}}$, $\tan \theta = -1$ is
- (A) $2n\pi \pm \frac{\pi}{6}$, $n \in I$ (B) $2n\pi \pm \frac{7\pi}{4}$, $n \in I$
(C) $n\pi + (-1)^n \frac{\pi}{3}$, $n \in I$ (D) $n\pi + (-1)^n \frac{\pi}{4}$, $n \in I$
105. The general solution of the equation $4 \sin^4 x + \cos^4 x = 1$ is
- (A) $x = 2n\pi$ (B) $x = n\pi + 1$
(C) $x = (n+2)\pi$ (D) $x = n\pi$ or $n\pi \pm \sin^{-1} \sqrt{\frac{2}{5}}$



106. The sides of triangle ABC are $AB = \sqrt{13}$ cm, $BC = 4\sqrt{3}$ cm, $CA = 7$ cm. Then $\sin \theta$, where θ is the smallest angle of the triangle is equal to

(A) $\frac{\sqrt{3}}{2}$ (B) $\frac{1}{2}$
(C) $\frac{\sqrt{3}-1}{2\sqrt{2}}$ (D) $\frac{3}{2}$

107. If $\sin(A+B+C) = 1$, $\tan(A-B) = \frac{1}{\sqrt{3}}$ and $\sec(A+C) = 2$, then

(A) $A = 90^\circ$, $B = 60^\circ$, $C = 30^\circ$ (B) $A = 120^\circ$, $B = 60^\circ$, $C = 30^\circ$
(C) $A = 60^\circ$, $B = 30^\circ$, $C = 0^\circ$ (D) $A = 60^\circ$, $B = 30^\circ$, $C = 30^\circ$

108. If in a triangle ABC , $a = 6$ cm, $b = 8$ cm, $c = 10$ cm, then the value of $\sin 2A$ is

(A) $\frac{6}{25}$ (B) $\frac{8}{25}$
(C) $\frac{10}{25}$ (D) $\frac{24}{25}$

109. In a triangle ABC , if $b+c=2a$ and $\angle A = 60^\circ$, then triangle ABC is

(A) equilateral (B) right angled
(C) isosceles (D) scalene



110. The solution of $\sin^{-1} x - \sin^{-1} 2x = \pm \frac{\pi}{3}$ is
- (A) $\pm \frac{1}{3}$ (B) $\pm \frac{1}{4}$
(C) $\pm \frac{\sqrt{3}}{2}$ (D) $\pm \frac{1}{2}$
111. If the mean of n observation $1^2, 2^2, 3^2, \dots, n^2$ is $\frac{46n}{11}$, then n is equal to
- (A) 11 (B) 12
(C) 23 (D) 22
112. The standard deviation of n observation $x_1, x_2, x_3, \dots, x_n$ is 2. If $\sum_{i=1}^n x_i = 20$ and $\sum_{i=1}^n x_i^2 = 100$, then n is
- (A) 10 or 20 (B) 5 or 10
(C) 5 or 20 (D) 5 or 15
113. If the coefficient of variation of a distribution is 45% and the mean is 12, then its standard deviation is
- (A) 5.2 (B) 5.3
(C) 5.4 (D) 10.8
114. If a point $P(4,3)$ is shifted by a distance $\sqrt{2}$ units parallel to the line $y = x$, then coordinates of P in the new position are
- (A) $(5, 4)$ (B) $(5 + \sqrt{2}, 4 + \sqrt{2})$
(C) $(5 - \sqrt{2}, 4 - \sqrt{2})$ (D) $(3, 4)$

115. If the lines $x^2 + 2xy - 35y^2 - 4x + 44y - 12 = 0$ and $5x + \lambda y - 8 = 0$ are concurrent, then the value of λ is
- (A) 0 (B) 1
(C) -1 (D) 2
116. If three distinct and real normals can be drawn to $y^2 = 8x$ from the point $(a, 0)$, then
- (A) $a > 2$ (B) $a \in (2, 4)$
(C) $a < 4$ (D) $a > 4$
117. If the line $y = 2x + c$ is tangent to the ellipse $\frac{x^2}{8} + \frac{y^2}{4} = 1$, then the value of c is
- (A) ± 6 (B) $\pm 2\sqrt{7}$
(C) $\pm 2\sqrt{5}$ (D) $\pm 2\sqrt{3}$
118. The sum of the distances of a point $(2, -3)$ from the foci of an ellipse $16(x-2)^2 + 25(y+3)^2 = 400$ is
- (A) 8 (B) 6
(C) 50 (D) 32
119. If $\sin^{-1} x + \sin^{-1} y = \frac{\pi}{2}$, then $\frac{dy}{dx}$ is equal to
- (A) $\frac{-x}{y}$ (B) $\frac{x}{y}$
(C) $\frac{y}{x}$ (D) $\frac{-y}{x}$



120. If $f(x^5) = 5x^3$, then $f'(x)$ is equal to

- (A) $\frac{3}{\sqrt[3]{x^2}}$ (B) $\frac{3}{\sqrt[3]{x}}$
(C) $\frac{3}{x}$ (D) $\sqrt[3]{x}$

121. If $y = \tan^{-1}(\sec x - \tan x)$, then $\frac{dy}{dx}$ is equal to

- (A) 2 (B) -2
(C) $\frac{1}{2}$ (D) $-\frac{1}{2}$

122. If $y = e^{ax} \sin bx$, then $\frac{d^2y}{dx^2} - 2a\frac{dy}{dx} + a^2y$ is equal to

- (A) 0 (B) 1
(C) $-b^2y$ (D) $-by$

123. If $\sin y = x \sin(a + y)$, then $\frac{dy}{dx}$ is

- (A) $\frac{\sin a}{\sin^2(a + y)}$ (B) $\frac{\sin^2(a + y)}{\sin a}$
(C) $\sin a \sin^2(a + y)$ (D) $\frac{\sin^2(a - y)}{\sin a}$

124. The function $f(x) = \log\left(\frac{1+x}{1-x}\right)$ satisfies the equation

(A) $f(x+2) - 2f(x+1) + f(x) = 0$

(B) $f(x) + f(x+1) = f\{x+(x+1)\}$

(C) $f(x) + f(y) = f\left(\frac{x+y}{1+xy}\right)$

(D) $f(x+y) = f(x)f(y)$

125. If $f: R \rightarrow R$ is defined by $f(x) = x^3$, then $f^{-1}(8)$ is equal to

(A) $\{2, 0\}$

(B) $\{2, 2\omega, 2\omega^2\}$

(C) $\{2, -2\}$

(D) $\{2\}$

PHYSICS

126. A sphere has a mass of 12.2 ± 0.1 kg and radius 10 ± 0.1 cm. The maximum % error in density is

(A) 1.22

(B) 3.83

(C) 1.33

(D) 0.38

127. A bus is standing at the bus stop. A man is in front of the bus at the stop. Suddenly the bus starts moving with an acceleration of 2 ms^{-2} . The man notices the bus moving after 2 seconds of its motion. With what constant speed the man should run so as to get into the bus in two seconds when he notices the bus moving?

(A) 4 ms^{-2}

(B) 2 ms^{-2}

(C) 8 ms^{-2}

(D) 6 ms^{-2}



10114

Series A

27

128. A stone is dropped from a height of 100 m and simultaneously a stone is thrown up from ground with a velocity 40 m/s. They cross each other after
- (A) 2 s (B) 2.5 s
(C) 2.2 s (D) 1.2 s
129. The momentum of a body is increased by 20%. Find the percentage increase in kinetic energy.
- (A) 30% (B) 44%
(C) 35% (D) 20%
130. A simple pendulum has a time period T_1 when on Earth's surface and T_2 when taken to a height R above the Earth's surface. R is the radius of the Earth. The value of T_2/T_1 is
- (A) 2 (B) 4
(C) 1 (D) $\sqrt{2}$
131. The radius of Earth is 6500 km. The mass of the Earth is 10 times the mass of Mars. An object weighs 100 N on the Earth's surface. Then its weight on the surface of the Mars' is (assume the diameter of the Earth and Mars is same)
- (A) 10 N (B) 20 N
(C) 80 N (D) 65 N
132. A cube of side a is placed on an inclined plane of inclination θ . What is the maximum value of θ for which cube will not topple?
- (A) 60° (B) 15°
(C) 30° (D) 45°



133. When equal volumes of two metals are mixed together, the specific gravity of the alloy is 4. When equal masses of the same metals are mixed together the specific gravity of the alloy is 3. What is the specific gravity of each metal?
- (A) 4, 3 (B) 3, 5
(C) 2, 6 (D) 4, 2
134. A soft polythene bag weighs W when empty. It is filled with air of density ρ and weighed in air. Then what is its weight if the volume of the bag is V ?
- (A) $W + V\rho g$ (B) W
(C) $W - V\rho g$ (D) None of the above
135. The density of water is greater than the density of air. Even then clouds containing water vapour float. Because
- (A) clouds have large amount of air
(B) clouds actually come down with a very small terminal velocity
(C) clouds actually move up with a very small terminal velocity
(D) the droplets in clouds are in the form of bubbles
136. The temperature of a black body increases from T to $2T$. The factor by which the rate of emission will increase is
- (A) 8 (B) 2
(C) 16 (D) 4



137. Which of the substances A, B and C has the highest specific heat? The temperature versus time graph is shown.

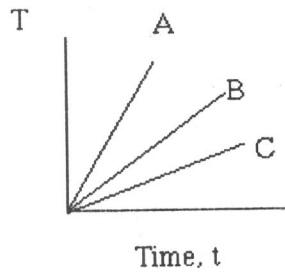

- (A) A
(B) C
(C) B
(D) All have equal specific heat
138. A block of ice at -10°C is slowly heated and converted into steam at 100°C . Which of the following curves represents the phenomenon qualitatively?

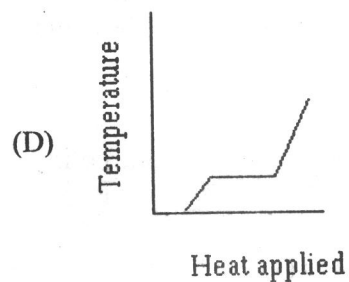
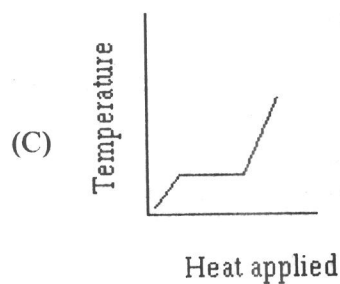
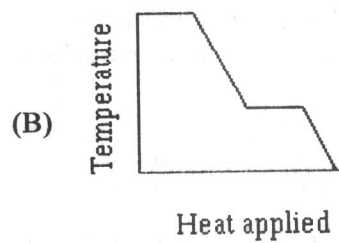
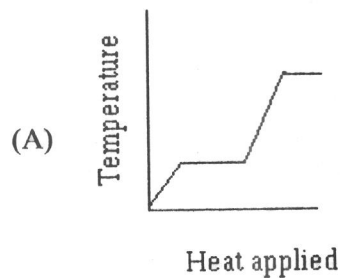



139. Two gases having same pressure P and volume V are mixed at a temperature T . If the mixture is at a temperature T and occupies the same volume V , then pressure of the mixture would be
- (A) $2P$ (B) P
(C) $P/2$ (D) $3P$
140. A man has a total surface area of 1.5 m^2 . Find the total rate of radiation of energy from the body.
(Stefan constant $5.67 \times 10^{-8} \text{ W m}^{-2} \text{ K}^{-4}$)
- (A) 566 J/s (B) 782 J/s
(C) 732 J/s (D) 682 J/s
141. Two copper spheres, one large size and the other small are heated to the same temperature. Which one will cool first?
- (A) Both in equal time (B) Insufficient data to reply
(C) Smaller (D) Larger
142. A particle is executing motion $x = A \cos(\omega t - \theta)$. Then the maximum velocity of the particle is
- (A) $A\omega$ (B) $A\omega \cos \theta$
(C) $A\omega \sin \theta$ (D) $A \sin \theta$
143. The bob of a pendulum is a hollow cylinder filled with sand. The bottom of the cylinder has a hole. The cylinder is set into oscillation. As the sand comes out of the hole
- (A) the time period first decreases and then increases
(B) the time period decreases
(C) the time period increases
(D) the time period first increases and then decreases
144. The fundamental frequency of a string is proportional to
- (A) inverse of the length (B) tension
(C) the diameter (D) density



145. The charge Q_1 and Q_2 are fixed at A and B . A unit charge is taken from A to B along the line joining AB . Then the force experienced by the unit charge
- (A) increases continuously
 - (B) first decreases and then increases
 - (C) decreases continuously
 - (D) first increases and then decreases
146. Three capacitors of $4 \mu\text{F}$ each are to be connected in such a way that the net capacitance is $6 \mu\text{F}$. Then
- (A) connect two in parallel and one in series
 - (B) connect two in series and one in parallel
 - (C) all the three be in parallel
 - (D) all the three be in series
147. A 100 W and 30 W bulbs of 220 V working voltage are connected in series. The net power consumed is
- (A) 12 W
 - (B) 30 W
 - (C) 23 W
 - (D) 130 W
148. A charged particle moves along a circle under the action of possible electric and magnetic fields. Which of the following is possible?
- (A) $E \neq 0, B = 0$
 - (B) $E = 0, B \neq 0$
 - (C) $E = 0, B = 0$
 - (D) $E \neq 0, B \neq 0$
149. The area under the magnetic hysteresis loop is proportional to
- (A) magnetic energy density
 - (B) thermal energy per unit volume
 - (C) electrical energy per unit volume
 - (D) mechanical energy per unit volume

150. The temperature at which an antiferromagnetic substance changes to paramagnetic is called

- (A) Absolute temperature (B) Curie temperature
(C) Neel temperature (D) Carnot heat

151. A magnet drops down through a long vertical copper tube. Its velocity as it falls down the tube

- (A) remains constant
(B) increases
(C) decreases
(D) increases first and then decreases

152. If A and B are identical bulbs, which bulb glows brighter?

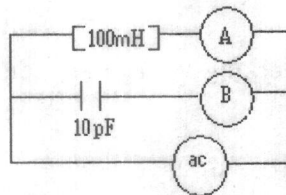

- (A) A (B) B
(C) both equally bright (D) cannot say

153. The radiations emitted by a human body

- (A) lie in UV region
(B) lie in IR region
(C) emitted during summer and absorbed during winter
(D) emitted only during night

154. A light of wavelength 5000 \AA is incident on a metal whose work function is 2 eV. The maximum KE of the photo electron will be

- (A) 0.48 eV (B) 0.2 eV
(C) 2 eV (D) 1.5 eV



155. An electron oscillating with a frequency of 3×10^6 Hz would generate
- (A) X-rays (B) microwaves
(C) radio waves (D) UV rays
156. If R is the radius and A is the mass number, then log R versus log A graph will be
- (A) a straight line (B) a parabola
(C) an ellipse (D) None of the above
157. A doped semiconductor has impurity level 30 meV below the conduction band. Which type of material is it?
- (A) n type (B) p type
(C) intrinsic (D) n or p type
158. In which of the case potential drop across the pn junction is equal?

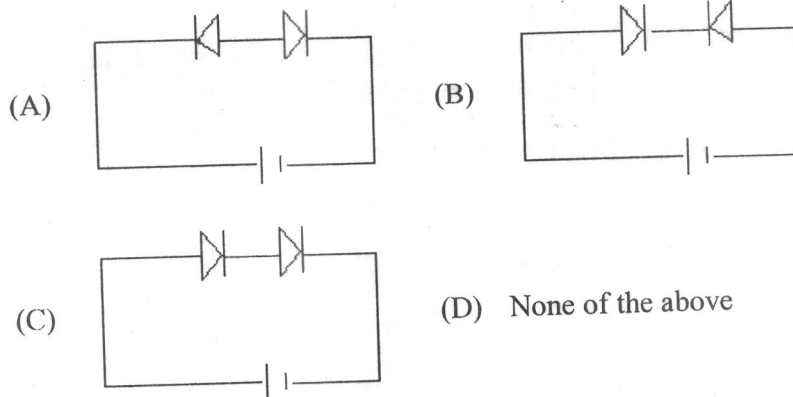

159. RF oscillator is not used
- (A) in generation of carrier wave
(B) as a low pass filter
(C) in watches
(D) as local oscillator in a transmitter



160. If the band gap of a LED is 0.8 eV, then the wavelength of the light emitted by the diode is
- (A) 15.5 nm (B) 155.0 nm
(C) 1.25 nm (D) 1553 nm
161. A capacitor has a capacitance of 6 μF in air. When a dielectric material is filled between the parallel plates, its capacitance increases to 30 μF . What will be the dielectric constant of the material introduced?
- (A) 5 (B) 10
(C) 20 (D) 30
162. In the centre of gravity of the positive charge and the centre of gravity of the negative charge are separated.
- (A) polar molecules (B) non polar molecules
(C) dielectric materials (D) semiconductors
163. When a glass rod is rubbed with silk, silk acquires a charge of $-4.8 \times 10^{-12} \text{C}$. The number of electrons it has is
- (A) gained, 3×10^7 electrons
(B) lost, 3×10^7 electrons
(C) gained, 0.333×10^7 electrons
(D) lost, 0.333×10^7 electrons
164. Material having negative temperature coefficient of resistance is
- (A) copper (B) germanium
(C) lead (D) platinum
165. A bread toaster having resistance of 115 ohms was operated at 230 V for 75 s to toast a bread slice. The total charge passed through the toaster is
- (A) 10 C (B) 50 C
(C) 150 C (D) 600 C



10114

Series A

166. When a material has specific resistance and melting point, then it can be used as the heating element.
- (A) low, low (B) low, high
(C) high, low (D) high, high
167. A galvanometer of resistance 30 ohms produces full scale deflection for a current of 50 mA. It can be converted as an ammeter of range 0–20 A by connecting a resistance of in series.
- (A) 0.075 ohms (B) 1.5 ohms
(C) 37 ohms (D) 370 ohms
168. Find the resistance offered by the compact fluorescent lamp of 18 W working in 230 V.
- (A) 12.8 ohms (B) 1.41 ohms
(C) 2939 ohms (D) 4140 ohms
169. originally designed the a.c. generator.
- (A) Michael Faraday (B) Foucault
(C) Nikola Tesla (D) Christian Oersted
170. Hysteresis loss can be minimised by using
- (A) thick wires of low resistance
(B) core made of mumetal alloy
(C) laminated core made up of stelloy
(D) shell type of core
171. When a current of 4 A flowing in one coil changes to 12 A in one second, then it induces an emf of 100 mV in the other coil. Find the mutual inductance.
- (A) 1.25 mH (B) 12.5 mH
(C) 125 mH (D) 1.25 H



172. Find the effective current flowing in the circuit of a capacitor of capacitance $1 \mu\text{F}$ connected in an a.c. circuit of frequency 50 Hz and the rms value of the applied voltage 150 V.
- (A) 3.184 A (B) 0.0318 A
(C) 0.471 A (D) 0.047 A
173. Frequency range of micro waves lies in the range of Hz.
- (A) 10^4 to 10^7 (B) 10^9 to 10^{11}
(C) 10^{14} to 10^{17} (D) 10^{18} to 10^{22}
174. When a 300 mm long tube filled with 60 cc of sugar solution produces an optical rotation of 9° , find the quantity of sugar in the solution (ρ for sugar is $6^\circ/\text{cm}$)
- (A) 3 mg (B) 30 mg
(C) 300 mg (D) 3 gm
175. Tyndall's effect associated with collidal particles is due to of light.
- (A) absorption (B) transmission
(C) reflection (D) scattering
176. Find the angle of refraction, when an unpolarised light is incident on a medium of refractive index 1.732 at the polarising angle.
- (A) 30° (B) 45°
(C) 60° (D) 90°
177. Mass spectrometer used to determine the isotopic masses was invented by
- (A) Bainbridge (B) Bragg
(C) Millikan (D) Rayleigh



178. A Coolidge tube operating at 24800 V emits X-radiation of maximum frequencyHz
- (A) 6×10^{12} (B) 6×10^{14}
(C) 6×10^{16} (D) 6×10^{18}
179. The magnetic Lorentz force experienced by the electron in the magnetic field is
- (A) Ee (B) BEv
(C) Bev (D) B^2v
180. Isotopes have
- (A) same A but different Z
(B) same Z but different A
(C) same number of protons but different number of neutrons
(D) same number of neutrons but different number of protons
181. In the reaction ${}_3\text{Li}^7 + X \rightarrow {}_4\text{Be}^7 + {}_0\text{n}^1$ the projectile X is
- (A) α particle (B) deuteron
(C) neutron (D) proton
182. The diamagnetism in a material is due to
- (A) orbital motion of the electron
(B) spin of electrons
(C) spontaneous magnetisation
(D) hysteresis behaviour
183. The susceptibility of a paramagnetic material is
- (A) negative and small (B) negative and large
(C) positive and small (D) positive and large

184. The magnetic moment of gadolinium per atom is $7.1 \mu_B$. Determine the magnetic moment per gram in Am^2 (atomic weight of gadolinium is 157.3)
- (A) 3.836×10^{21} (B) 2.724×10^{22}
(C) 9.469×10^{25} (D) 0.253
185. Hysteresis is the characteristic of the materials
- (A) diamagnetic (B) paramagnetic
(C) ferromagnetic (D) All of the above
186. A person runs first 10 m with the speed of 2 m/s, the next 12 m with the speed of 3 m/s and next 8 m with 4 m/s. Then the average velocity is
- (A) 10 m/s (B) 11 m/s
(C) 3 m/s (D) 2.73 m/s
187. A coin is tossed vertically upward with an initial speed of 12 m/s from a building of height 37.8 m. When will it reach the ground? (assume $g = 10 \text{ m/s}^2$)
- (A) 1.2 s (B) 2.4 s
(C) 3.0 s (D) 3.6 s
188. The direction of angular velocity is along the
- (A) radius towards the centre
(B) radius away from the centre
(C) axis of rotation
(D) tangent to circular path
189. A car is moving at 72 km/h. When a person sitting in the car drops a bag on the road through the window, then the path of the bag seen by the observer standing on the road will be
- (A) straight line (B) circle
(C) ellipse (D) parabola



10114

39

Series A

190. A boiler of mass 2000 gm at rest explodes into two pieces of mass 1.2 kg and 0.8 kg. The larger mass piece moves with a speed of 15 m/s. Find the speed of the motion of smaller mass piece.
- (A) -10 m/s (B) -12.5 m/s
(C) -17.5 m/s (D) -22.5 m/s
191. ${}_{92}\text{U}^{235}$ nucleus emits an α particle with a velocity of 10 m/s and recoils. Find the recoil velocity of the nucleus.
- (A) 557.5 m/s (B) 567.5 m/s
(C) 577.5 m/s (D) 587.5 m/s
192. A simple pendulum of length 100 cm is moving with a speed of 6 m/s, while passing through its lowest position. Find its speed when it makes an angle of 45° with the vertical. ($g=10 \text{ m/s}^2$)
- (A) 4.71 m/s (B) 5.10 m/s
(C) 5.49 m/s (D) 5.98 m/s
193. When the mass and radius of the Earth are decreased by 2%, the value of acceleration due to gravity
- (A) increases by 2% (B) decreases by 2%
(C) increases by 4% (D) decreases by 4%
194. One astronomical unit (AU) is equal to
- (A) $1.496 \times 10^{11} \text{ m}$ (B) $9.467 \times 10^{15} \text{ m}$
(C) $6.673 \times 10^{-11} \text{ N m}^2\text{kg}^{-2}$ (D) $5.98 \times 10^{24} \text{ kg}$
195. Mass of a body is 49 kg. What will be its weight on the surface of the Earth?
- (A) 2 N (B) 5 N
(C) 49 N (D) 480 N



196. In a pn junction at the middle of the depletion layer the
is maximum.
- (A) electric field intensity (B) space charge density
(C) electrostatic potential (D) electro motive force
197. An ordinary pn junction diode acts as a
- (A) d.c voltage regulator (B) rectifier
(C) oscillator (D) amplifier
198. Which one of the following has highest power gain?
- (A) CE amplifier (B) CB amplifier
(C) CC amplifier (D) Push-pull amplifier
199. The operation of thermocouple is to convert
- (A) temperature to displacement
(B) temperature to electric current
(C) temperature to phase
(D) force to displacement
200. If a square wave is given as an input to an integrator circuit, the output wave will be
- (A) sine (B) triangle
(C) saw-tooth (D) pulse

CHEMISTRY

201. Ethyl alcohol cannot be used as a solvent for CH_3MgI because
- (A) CH_3MgI reacts with alcohol giving methane
(B) the reaction between them is explosive in nature
(C) CH_3MgI is converted to $\text{C}_2\text{H}_5\text{MgI}$
(D) Alcohol is immisible with CH_3MgI



10114

Series A

41

202. During reduction of aldehydes with hydrazine and C_2H_5ONa the product formed is
- (A) $R-CH=N-NH_2$ (B) $R-C\equiv N$
(C) $RCONH_2$ (D) $R-CH_3$
203. A cyanohydrin of a compound X on hydrolysis gives lactic acid. The compound X is
- (A) $HCHO$ (B) CH_3CHO
(C) $(CH_3)_2CO$ (D) $C_6H_5CH_2CHO$
204. Aniline differs from ethylamine by the reaction with
- (A) metallic sodium
(B) an alkyl halide
(C) chloroform and caustic potash
(D) nitrous acid
205. Diazonium salts give coupling reactions with
- (A) alcohol (B) aromatic amines
(C) all amines (D) amines and phenols
206. The compound which acts both as antipyretic as well as analgesic is
- (A) phenacetin (B) sulpha drugs
(C) paracetamol (D) aspirin
207. Inversion of sucrose refers to
- (A) oxidation of sucrose
(B) reduction of sucrose
(C) hydrolysis of sucrose to glucose and fructose
(D) polymerisation of sucrose

208. When alcohols are converted to alkyl chlorides by thionyl chloride in the presence of pyridine, the intermediate formed is

- (A) sulphonium ion
(B) chlorosulphonic acid
(C) alkyl chlorosulphite
(D) chlorosulphite

209.
$$\begin{array}{c} \text{C}_6\text{H}_5\text{C}-\text{C}-\text{C}_6\text{H}_5 \\ \parallel \quad \parallel \\ \text{O} \quad \text{O} \end{array}$$
 upon reaction with KOH followed by acidification gives

- (A) $\text{C}_6\text{H}_5-\text{CH}(\text{OH})-\text{CO}-\text{C}_6\text{H}_5$
(B) $\text{C}_6\text{H}_5-\text{COOH} + \text{C}_6\text{H}_5\text{CH}_2\text{OH}$
(C) $\text{C}_6\text{H}_5(\text{CHOH})_2\text{C}_6\text{H}_5$
(D) $(\text{C}_6\text{H}_5)_2\text{C}(\text{OH})\text{COOH}$

210. Which of the following structures is not meso-2, 3-butane diol?

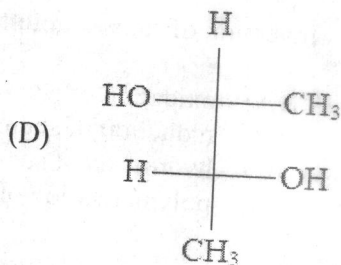
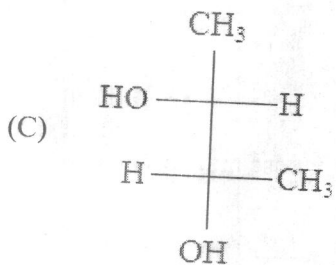
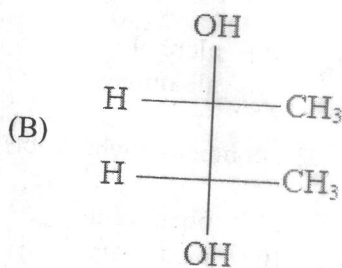
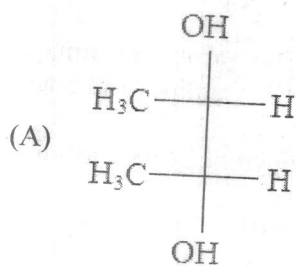



10114

43

Series A



- (A) $\text{C}_6\text{H}_5\text{CHOHCOOH}$ (B) $\text{C}_6\text{H}_5\text{CH}_2\text{COOH}$
(C) $\text{C}_6\text{H}_5\text{CHOHCH}_2\text{OH}$ (D) $\text{C}_6\text{H}_5\text{COCH}_2\text{OH}$

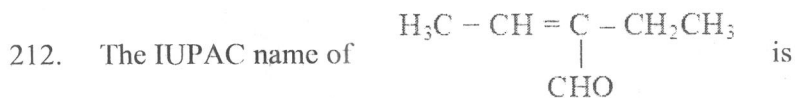

- (A) 3-formyl-2-pentene (B) 2-ethylbut-2-enal
(C) 3-ethylbut-3-enal (D) 2-ethylcrotonaldehyde

213. What is the major product when *t*-butylbenzene is nitrated?

- (A) *p*-nitro-*t*-butylbenzene (B) 2,6-dinitro-*t*-butylbenzene
(C) *o*-nitro-*t*-butylbenzene (D) *m*-nitro-*t*-butylbenzene

214. What product is obtained when CH_3CONH_2 is treated with bromine and sodium hydroxide?

- (A) CH_3COOH (B) CH_3NH_2
(C) $\text{C}_2\text{H}_5\text{NH}_2$ (D) $\text{CH}_3\text{CH}_2\text{Br}$

215. What is the major product obtained in the following reaction?

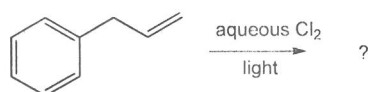

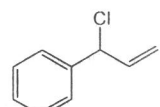
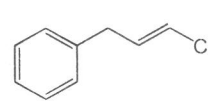
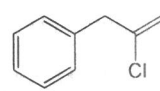
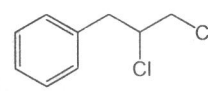
- (A)  (B) 
(C)  (D) 

216. What product is obtained in the following reaction?

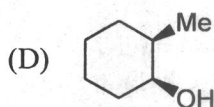
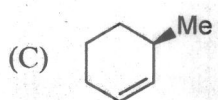
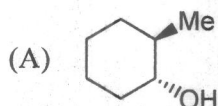
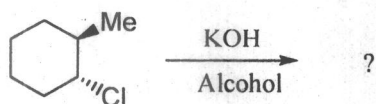

217. What is the major product obtained in the following reaction?

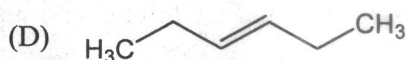
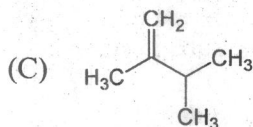
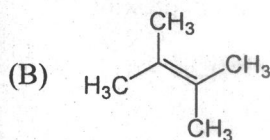
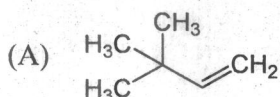
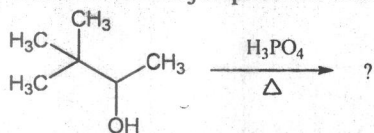

218. From each pair given below, identify the ion which is larger in size.

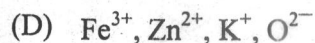
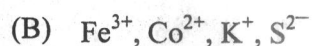
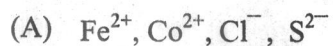
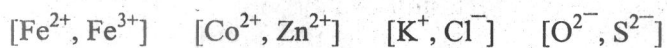



10114

45

Series A

219. 20 ml 0.10 M sodium hydroxide is added to 15 ml 0.10 M sulphuric acid and the resultant solution is titrated against 0.10 M sodium carbonate. What will be the titre value at the end point?
- (A) 5 ml (B) 10 ml
(C) 20 ml (D) 30 ml
220. CO_2^- radical can be produced by irradiating sodium formate with γ -rays. Its molecular structure is expected to be similar to
- (A) CO_3^- (B) NO_2
(C) CO_2 (D) N_3^-
221. The anion and cation are iso-electronic in
- (A) LiF (B) NaF
(C) RbI (D) CsCl
222. An element crystallises in the simple cubic lattice. How many atoms are there per unit cell?
- (A) 1 (B) 4
(C) 6 (D) 8
223. Which of the following is not a crystalline substance?
- (A) Glass (B) Quartz
(C) Zeolite (D) Diamond
224. The structure of PdCl_4^{2-} is similar to that of
- (A) NiCl_4^{2-} (B) $\text{Ni}(\text{CN})_4^{2-}$
(C) $\text{Fe}(\text{CO})_4^{2-}$ (D) CoCl_4^{2-}

225. The correct statement associated with the complex anion $[\text{CoF}_6]^{3-}$ is that
- (A) it is a low spin complex
(B) it is a high spin complex
(C) it is yellow in colour
(D) it is diamagnetic
226. A coordination complex has only two isomers, having octahedral coordination geometry. Identify the complex(es) among the following
 $[\text{Cr}(\text{H}_2\text{O})_5\text{Cl}]$; $[\text{Cr}(\text{H}_2\text{O})_3\text{Cl}_3]$; $[\text{Ni}(\text{NH}_3)_4\text{Cl}_2]$; $[\text{NH}_4]_4[\text{NiCl}_6]$
- (A) only $[\text{Cr}(\text{H}_2\text{O})_5\text{Cl}]$
(B) $[\text{Cr}(\text{H}_2\text{O})_3\text{Cl}_3]$ and $[\text{NH}_4]_4[\text{NiCl}_6]$
(C) $[\text{Cr}(\text{H}_2\text{O})_3\text{Cl}_3]$ and $[\text{Ni}(\text{NH}_3)_4\text{Cl}_2]$
(D) only $[\text{Ni}(\text{NH}_3)_4\text{Cl}_2]$
227. If hydrogen sulphide gas is passed through an acidified solution containing a mixture of the sulphates of cadmium, nickel and zinc, which sulphide(s) will be precipitated?
- (A) CdS and NiS
(B) NiS and ZnS
(C) NiS
(D) CdS
228. Which one of the following cannot be used for softening temporary hardness of water?
- (A) NH_3
(B) Na_2CO_3
(C) NH_4Cl
(D) $\text{Ca}(\text{OH})_2$
229. All the following substances react with water:
(a) Ca and CaH_2 (b) Na and Na_2O_2 (c) K and KO_2 . Which pair yields the same gaseous products?
- (A) (c) only
(B) (a) only
(C) (b) only
(D) (b) and (c) only



10114

Series A

47

230. Which of the following is not expected to display an oxidation state of +6 in any of its compounds?
- (A) Ti (B) Cr
(C) Mn (D) W
231. Which of the following complex ion would you expect to have largest overall stability constant?
- (A) $[\text{Co}(\text{NH}_3)_6]^{3+}$
(B) $[\text{Co}(\text{en})_3]^{3+}$ (en = ethylene diamine)
(C) $[\text{Co}(\text{H}_2\text{O})_6]^{3+}$
(D) $[\text{Co}(\text{H}_2\text{O})_4(\text{CH}_3\text{-NH}_2)_2]^{3+}$
232. Which of the following nuclides would you expect to be least stable?
- (A) ${}^8_8\text{O}^{18}$ (B) ${}^{40}_{20}\text{Ca}^{40}$
(C) ${}^6_3\text{Li}^6$ (D) ${}^{20}_{10}\text{Ne}^{20}$
233. Which 'd' orbital will have highest energy in a square planar crystal field?
- (A) d_{z^2} (B) d_{xy}
(C) $d_{x^2-y^2}$ (D) d_{yz}
234. Which of the following is not paramagnetic?
- (A) O_2 (B) NO
(C) MgCl_2 (D) C_6H_6^- (anion)



235. For an ionic crystal of the general formula AX and coordination number 6, the value of radius ratio will be
- (A) greater than 0.73 (B) in between 0.73 and 0.41
(C) in between 0.41 and 0.22 (D) less than 0.22
236. A gas will approach ideal behavior at
- (A) low temperature and low pressure
(B) low temperature and high pressure
(C) high temperature and low pressure
(D) high temperature and high pressure
237. The linear momentum, p , of a particle of mass, m , is related to its velocity, v , by
- (A) $\frac{1}{2} mv^2$ (B) mv
(C) $(mv)^{\frac{1}{2}}$ (D) $\frac{m}{v}$
238. A chemical reaction $A \rightleftharpoons B$ is said to be in equilibrium when
- (A) complete conversion of A to B has taken place
(B) conversion of A to B is only 50% complete
(C) only 10% conversion of A to B has taken place
(D) the rate of transformation of A to B is just equal to rate of transformation of B to A in the system
239. According to first law of thermodynamics
- (A) $\Delta E = q + w$ (B) $\Delta E = w - q$
(C) $w = q + \Delta E$ (D) None of the above



10114

Series A

49

240. The reaction $A \rightarrow B$ follows first order kinetics. The time taken for 0.8 mole of A to produce 0.6 mole of B is 1 hour. What is the time taken for conversion of 0.9 mole of A to produce 0.675 mole of B?
- (A) 0.5 h (B) 0.25 h
(C) 2 h (D) 1 h
241. Copper sulphate solution is electrolysed using copper electrodes. The reaction taking place at anode is
- (A) $H^+ + e^- \rightarrow H$ (B) $SO_4^{2-}(aq) \rightarrow SO_4 + 2e^-$
(C) $Cu^{2+} + 2e^- \rightarrow Cu$ (D) $Cu(s) \rightarrow Cu^{2+}(aq) + 2e^-$
242. In electrolysis of NaCl, when Pt electrode is taken, then H_2 is liberated at cathode; while with Hg cathode it forms sodium amalgam. This is because
- (A) Hg is more reactive than Pt
(B) more voltage is required to reduce H^+ at Hg than at Pt
(C) Na is dissolved in Hg while it does not dissolve in Pt
(D) conc. of H^+ ions is large when Pt electrode is taken
243. An open system
- (A) can exchange matter and energy with its surroundings
(B) can exchange energy with its surroundings, but it cannot exchange matter
(C) can exchange neither energy nor matter with its surroundings
(D) can exchange matter with its surroundings, but it cannot exchange energy



244. When an endothermic process takes place in an adiabatic container, it results in
- (A) lowering of temperature of the system
 - (B) rise of temperature
 - (C) no change in temperature
 - (D) rise in pressure
245. Nitrogen is heated to 500 K in a vessel of constant volume. If it enters the vessel at 100 atm and 300 K, what pressure would it exert at the working temperature if it behaved as a perfect gas?
- (A) 334 atm
 - (B) 167 atm
 - (C) 300 atm
 - (D) 760 atm
246. A catalyst is a substance that
- (A) accelerates a reaction but undergoes no net chemical change
 - (B) accelerates a reaction and undergoes net chemical change
 - (C) enhances the activation energy of the reaction
 - (D) lowers the velocity
247. In rock-salt structure
- (A) each cation is surrounded by eight anions
 - (B) each cation is surrounded by six anions
 - (C) each cation is surrounded by two anions
 - (D) each cation is surrounded by four anions
248. Arrange the following ions in the order of increasing ionic mobility H^+, Na^+, OH^-, Cl^-
- (A) $Cl^- < Na^+ < OH^- < H^+$
 - (B) $Na^+ < OH^- < Cl^- < H^+$
 - (C) $Na^+ < Cl^- < H^+ < OH^-$
 - (D) $Na^+ < Cl^- < OH^- < H^+$



10114

51

Series A

249. Choose the incorrect statement.

For a first order reaction

- (A) half-life of a reactant is independent of its initial concentration
- (B) half-life varies with initial concentration
- (C) unit is time^{-1}
- (D) None of the above is true

250. Unit of molar entropy is

- (A) J K^{-1}
- (B) $\text{J K}^{-1} \text{mol}^{-1}$
- (C) lit mol^{-1}
- (D) mol s^{-1}



SPACE FOR ROUGH WORK



SPACE FOR ROUGH WORK

SEAL



SPACE FOR ROUGH WORK

SPACE FOR ROUGH WORK

SEAL